

# *Digi-Pas*<sup>®</sup>

## USER MANUAL



## 2-Axis Ultra Precision Inclinometer

Model: DWL9000XY

Rev. 1.11

[www.digipas.com](http://www.digipas.com)

Note: Contents in this instruction manual is continuously updated, please check Digi-Pas website for latest version.

# CONTENT

- 1. Device Overview..... 1
  - 1.1. Technical Specification.....1
  - 1.2. Dimension of the Tilt Sensor Module .....2
  - 1.3. Overview .....3
  - 1.4. List of items included in DWL-9000XY product package.....4
- 2. Setting Up.....4
  - 2.1. Operation Procedure .....4
  - 2.2. Mounting Device On Fixture or Work Piece .....4
- 3. User Interface .....5
  - 3.1. Single Axis Mode Interface .....5
  - 3.2. Single Axis Mode Display Screen and Button Function .....5
  - 3.3. Single Axis Mode Operation .....6
  - 3.4. Dual-Axis Mode Display Screen and Button Function .....6
  - 3.5. Main Menu Icon Screen Display and Button Function .....7
  - 3.6. Main Menu Icon Features .....7
- 4. Features & Setting .....8
  - 4.1. Absolute Level Screen Display and Button Function .....8
  - 4.2. Alternate Zero Screen Display and Button Function.....9
  - 4.3. Sync Menu Screen Display and Button Function ..... 10
  - 4.4. Angle Meter Screen Display and Button Function..... 11
  - 4.5. Vibro Meter Screen Display and Button Function ..... 11
  - 4.6. Setting Menu Display Screen and Button Function..... 12
- 5. Storage & Cleaning ..... 13
- 6. Warranty ..... 13
- APPENDIX 1: User Calibration ..... 15



## INTELLECTUAL PROPERTY

This manual contains propriety information, which is protected by copyrights. All rights are reserved. No part of this manual may be photocopied, reproduced, redistributed or translated to another language without the prior written consent of Digipas Technologies Inc.

The information in this manual was correct at the time of printing, stored in CD or uploaded in the Company website. However, Digipas Technologies Inc. will continue to improve products and reserves the rights to change specification and maintenance procedures at any time without prior notice.

Digi-Pas® Products were manufactured under ISO9001 & ISO14001 standards, tested to comply by the followings certification bodies:



# 1. DEVICE OVERVIEW

## 1.1. Technical Specification

|                                    |   |
|------------------------------------|---|
| Measuring Range (Single Axis Mode) | 0 to 7200 arcsec.<br>(0.0000° to ± 2.0000°)                       |
| Measuring Range (2-Axis Mode)      | 0 to 3600 arcsec.<br>(0.0000° to ± 1.0000°)                       |
| Resolution                         | 0.2 arcsec. (≤ 1µm/M)   |
| Accuracy                           | ± 0.6 arcsec at 0 to ±100 arcsec.<br>± 1.2 arcsec at other angles |
| Repeatability                      | 0.2 arcsec. (≤ 1µm/M)   |
| Measurement Speed                  | ≤ 25 Sec.   |
| Vibrometer                         | 2.0g  |
| Display                            | Colour TFT LCD  |
| Power Supply                       | 4 x AAA 1.5V Batteries / USB Power source                         |
| Material                           | PC ABS / Alloy Steel  |
| Connectivity                       | USB 2.0 Cable (≤ 5 metre)<br>Bluetooth (≤30 metre)                |
| PC SYNC Software                   | Professional Edition (Included)                                   |
| Operating Temperature              | +10°C to +40°C<br>(Calibrated for the entire temperature range)   |
| Storage Temperature                | -20°C to +60°C  |
| Dimension (mm)                     | 188 x 62 x 37   |
| Nett Weight (Approx.)              | 1150 gram   |

**Table 1. Technical specification of DWL-9000XY Ultra Precision Inclinometer**

Notes:

- Product performance to specification complies with accredited Calibration & Test Providers in USA, Japan, UK, and Germany to conform with NIST, JIS, UKAS & DIN under the International Laboratory Accreditation Cooperation please visit "[www.digipas.com](http://www.digipas.com)".

1.2. Dimension of the Tilt Sensor Module

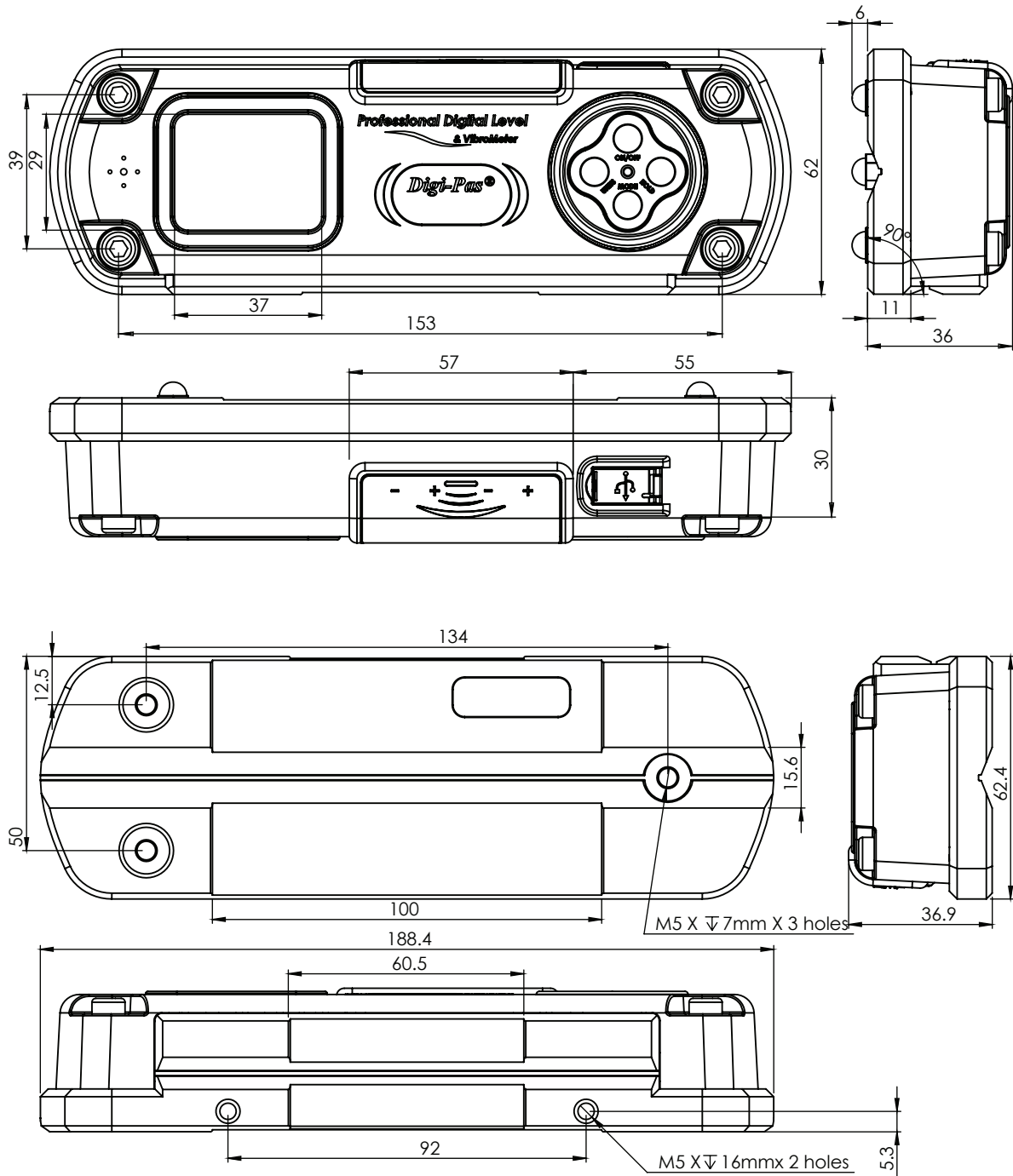
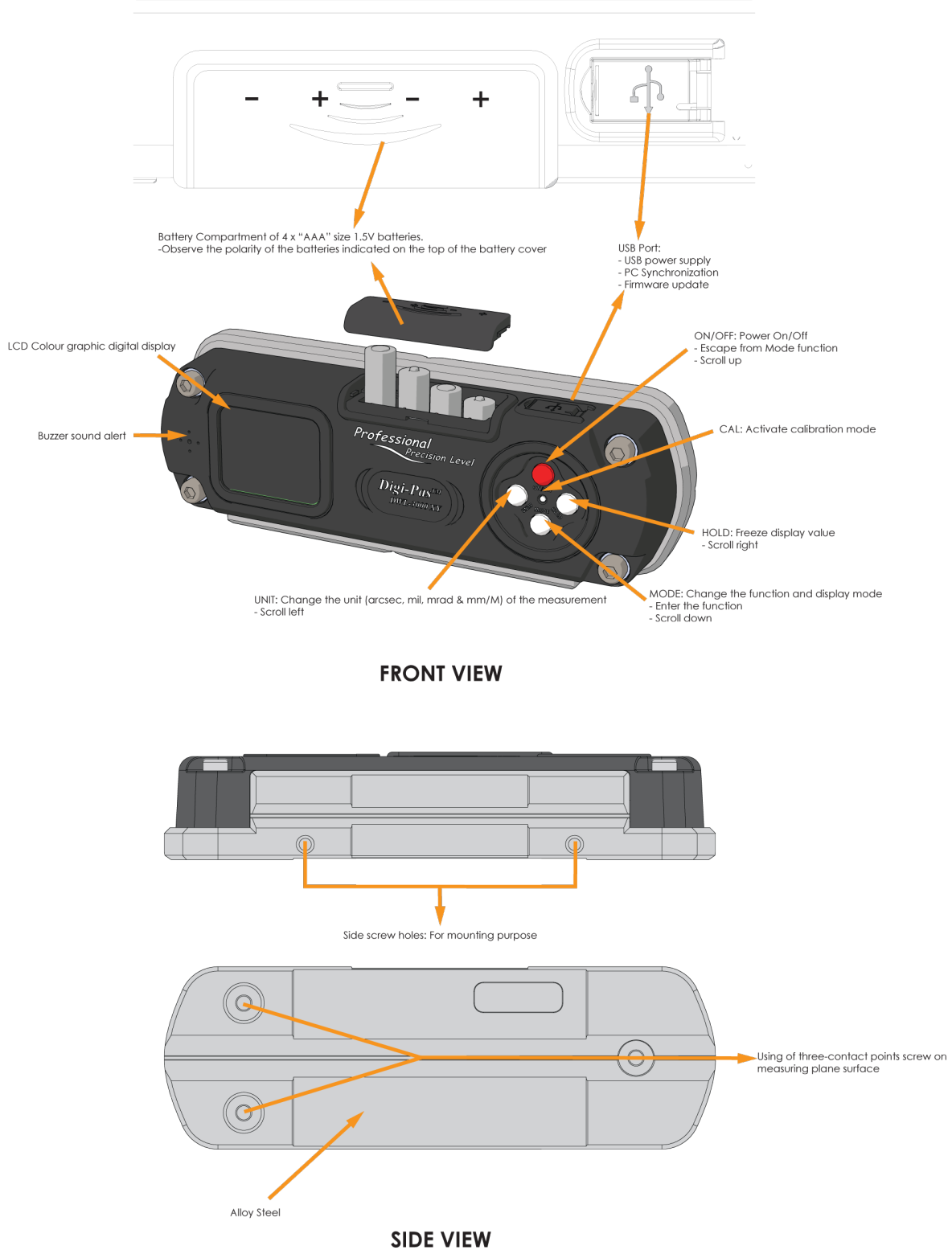

Figure 1. DWL-9000XY Device Dimension

## 1.3. Overview



## 1.4. List of items included in DWL-9000XY product package

| Item No. | Description                             | Quantity |
|----------|---|----------|
| 1        | DWL 9000XY Ultra Precision Inclinometer | 1 unit   |
| 2        | Certificate of Calibration              | 1 set    |
| 3        | AAA batteries                           | 4 pcs    |
| 4        | USB 2.0 cable (3 Meters)                | 1 pc     |
| 5        | PC Sync Redemption Card                 | 1 pc     |
| 6        | M5 Button head screws                   | 3 pcs    |

Table 1. Packaging content

## 2. SETTING UP

### 2.1. Operation Procedure

1. Insert 4 pieces of “AAA” batteries into the battery compartment and press ON/OFF button. Alternatively, insert USB power source to the USB Port to power up the device. Take note that the device performance might be affected when poorly regulated USB power source is used.



2. Initial Setup screen pops up. Press ON/OFF button to scroll up or MODE button to scroll down for selecting “Default Units” or “Current Device Location”. Press “UNITS” or “HOLD” button to input the selected option. Select the nearest option when your location is not available in the default list. Scroll to select “Done” to continue.
3. Allow sufficient time for the device to stabilize during initial power-up. When the thermometer on the screen turns green, the device is ready to use.

Note: For maximum accuracy, perform calibration (refer to APPENDIX: User Calibration) or Absolute Level (refer to Chapter 4: Absolute Level for more details) before measurement.

### 2.2. Mounting Device On Fixture or Work Piece

The two threaded holes are provided for mounting the device onto user-defined fixtures/machinery.

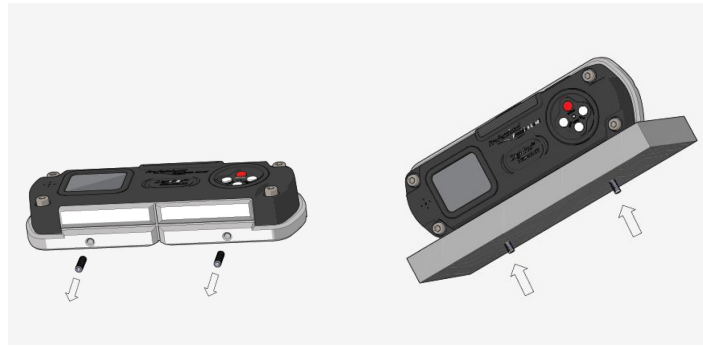

To mount the device onto user's defined fixture or workpiece. Remove both the set screw (M5), then replace with the appropriate type of screws specified by the user.

### 3. USER INTERFACE

#### 3.1. Single Axis Mode Interface



#### 3.2. Single Axis Mode Display Screen and Button Function

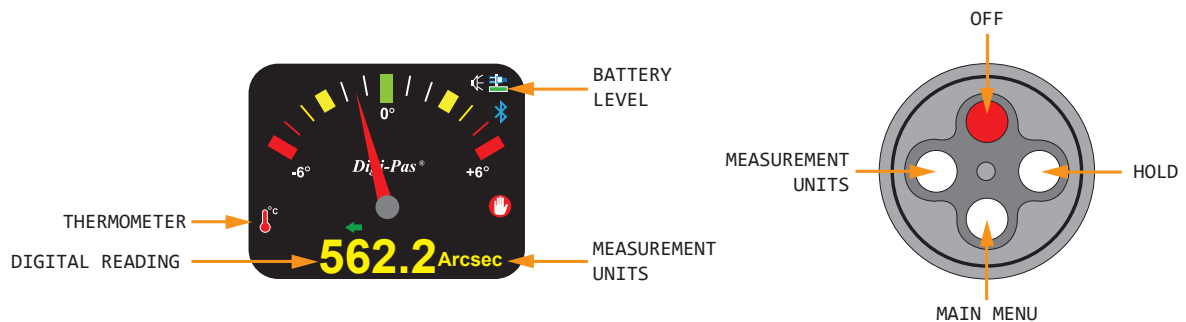

#### 3.3. Single Axis Mode Operation

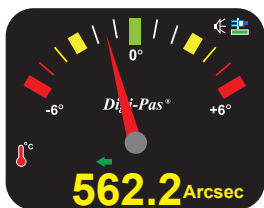

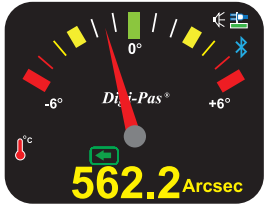

Place the digital level on the surface to be measured.

Please ensure the contact surfaces of the device and measuring plane are clean and free from dust particles.

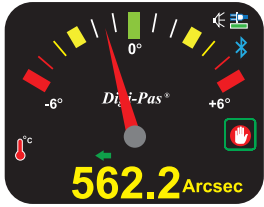

The green arrow sign on display indicates the higher side.



User may "freeze" the screen by pressing the HOLD button. The icon  pops up to indicate the screen is paused. To resume operation, press the hold button once.

### Dual-Axis Mode Interface



### 3.4. Dual-Axis Mode Display Screen and Button Function

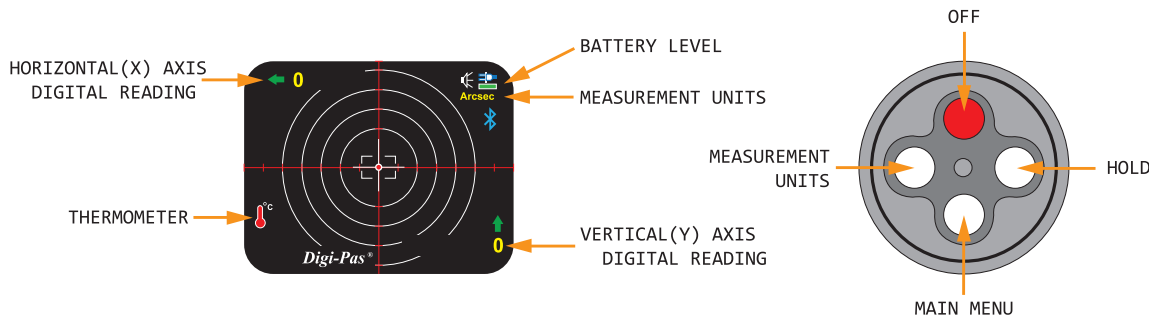

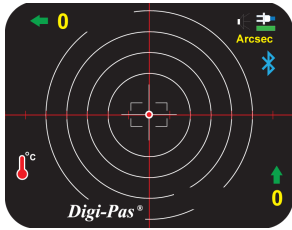

Place the digital level on the surface to be measured.

⚠ Please ensure the contact surfaces of the device and measuring plane are clean and free from dust particles.

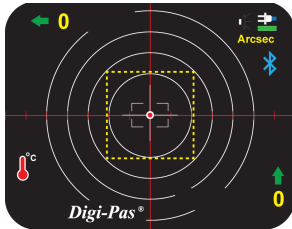

The "Target Ball" or "Bull Eye" move towards the measured position similar to traditional "Bubble" vials. The green arrow sign on display indicates the higher side of plane.

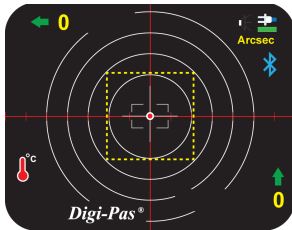

Once the measurement stabilizes, the "Target Ball" or "Bull Eye" blinks.

### 3.5. Main Menu Icon Screen Display and Button Function

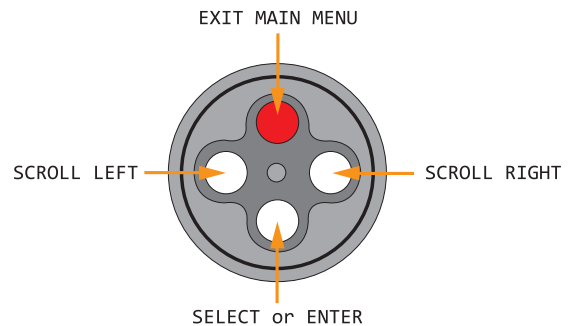

### 3.6. Main Menu Icon Features



#### ABSOLUTE LEVEL SETTING

Enable user to ensure each measurement reading is in accordance to maximum device accuracy specified.



#### ALTERNATE ZERO SETTING

Enable user to measure relative angles at a common plane with respect to a reference angle. Set any angle to 0" as a reference.



### SYNC MENU

Enables user to select the connectivity (USB/Bluetooth) with a computer installed with PC Sync Software.



### ANGLE METER

Enables user to obtain real-time continuous angle measurements displayed in line graph.



### VIBRO METER

Enables user to obtain real-time continuous vibration measurements displayed in line graph.



### SETTING MENU

Enable user to modify various parameters of the device.

## 4. FEATURES AND SETTING



### Absolute Level Screen Display and Button Function

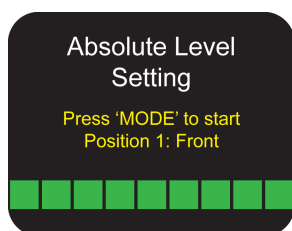
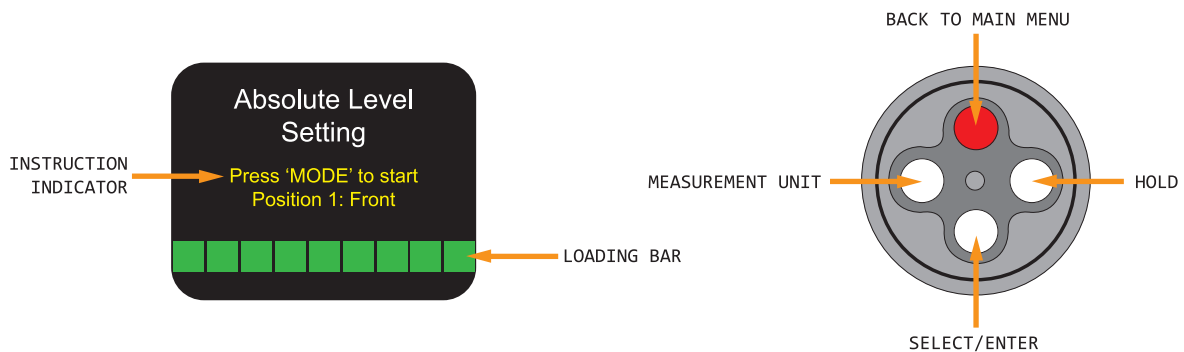

Place the device on the surface to be measured. Press MODE button to start the measurement and wait until the loading bar is full.

**⚠** Please ensure the contact surfaces of the device and measuring plane are clean and free from dust particles.

Note: The device is able to auto detect its position is single axis position or dual-axis.

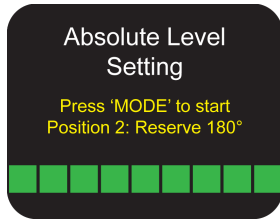

Turn the device 180° and press MODE button again to start the measurement.

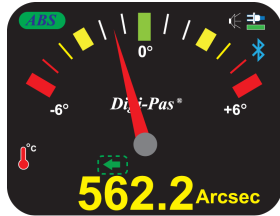

When completed the above settings, the 'ABS' logo is shown to indicate that the device is in the Absolute Level mode.



## Alternate Zero Screen Display and Button Function

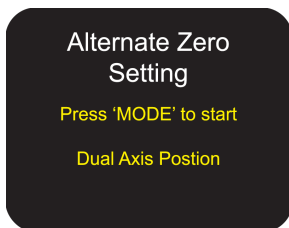
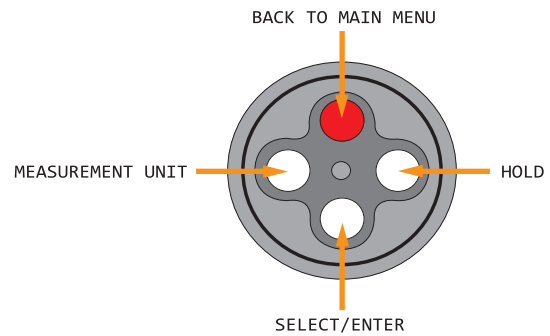
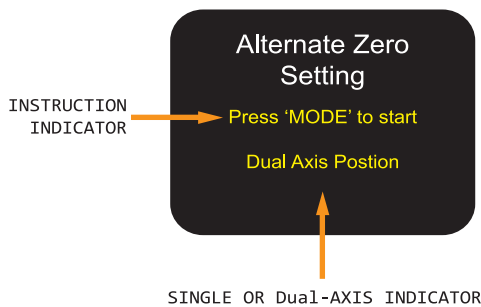

Place the digital level on the surface to be measured. Press MODE button to set the angle to 0" as a reference.

 Please ensure the contact surfaces of the device and measuring plane are clean and free from dust particles.

Note: The device is able to auto detect its position is single axis position or 2-axis.



The 'Alt. Zero' logo is shown to indicate that the device is in Alternate Zero mode.



User may “freeze” the screen by pressing the HOLD button. The icon pops up to indicate the screen is paused. To resume operation, press the hold button once.



## SYNC Menu Screen Display and Button Function

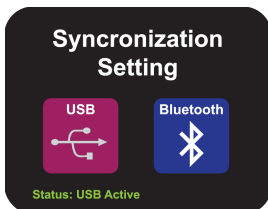
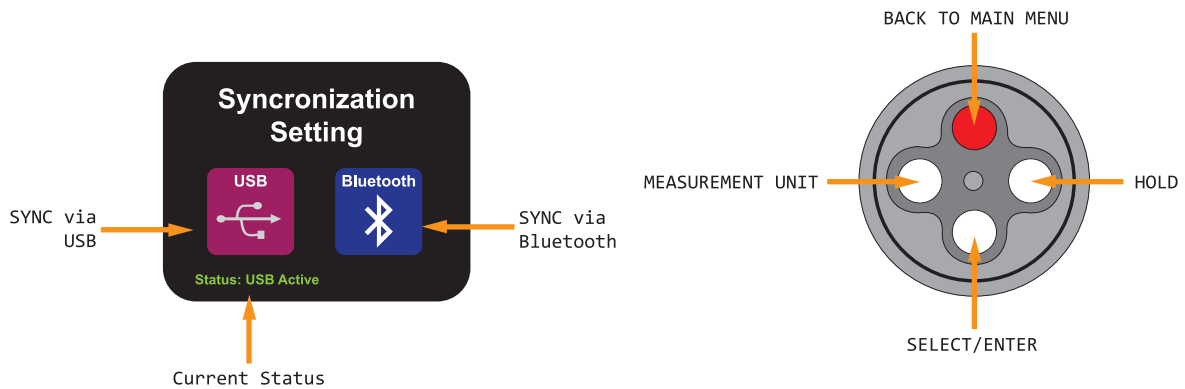

The status bar indicates current selected mode as USB. To change to Bluetooth mode, scroll the ‘right’ button and then press MODE button.



Reboot the device by turning off the device and then turn on the device again to activate the new setting.

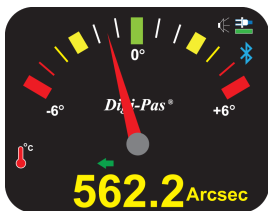

Once Bluetooth mode is activated, the Bluetooth Icon will appear on the top right display.



## Angle Meter Screen Display and Button Function

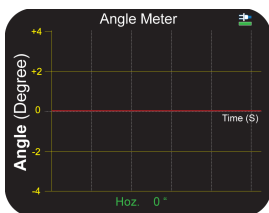
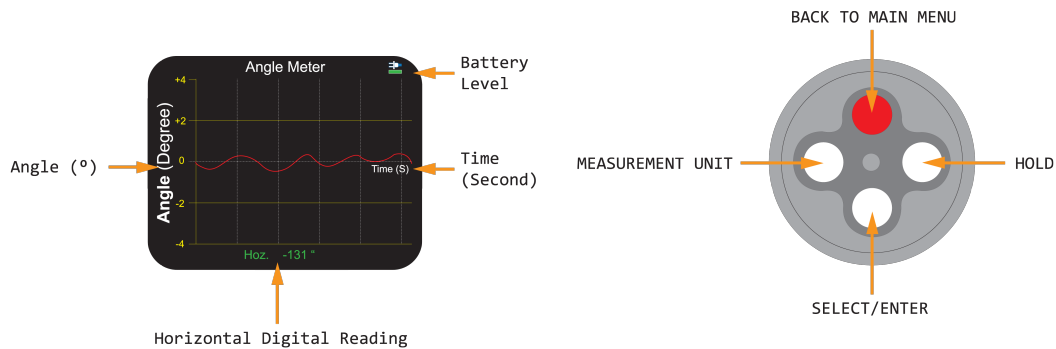

Place the digital level on the surface to be measured.

Please ensure the contact surfaces of the device and measuring plane are clean and free from dust particles.

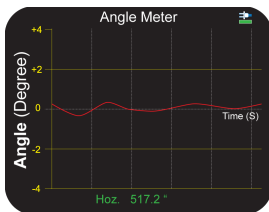

The Angle Meter displays real-time continuous angle measurements in line graph.

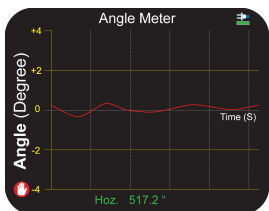

User may "freeze" the screen by pressing the HOLD button.

The icon pops up to indicate the screen is paused. To resume operation, press the hold button once.



## Vibro Meter Screen Display and Button Function

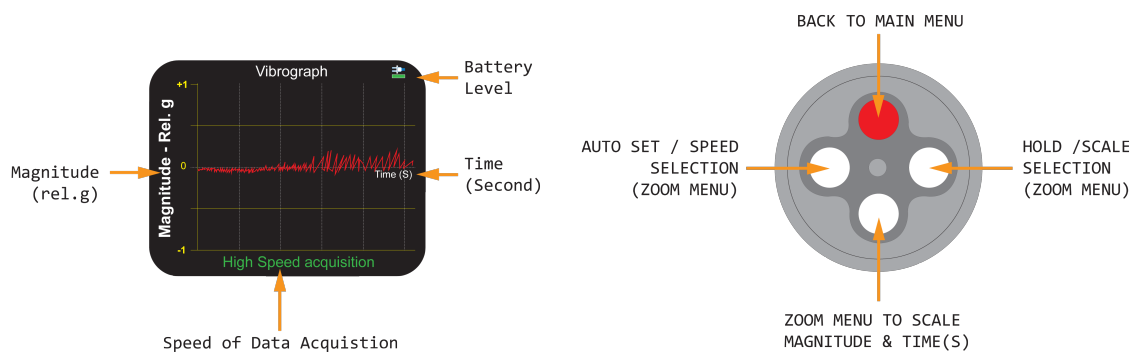

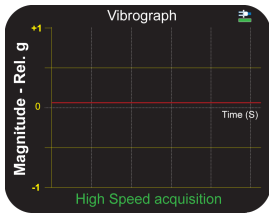

Place the device on the surface to be measured.

Press Auto Set button to set the line graph to the centre of display.

Please ensure the contact surfaces of the device and measuring plane are clean and free from dust particles.

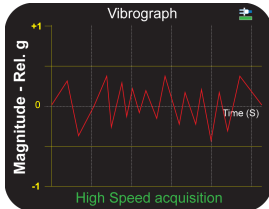

When the device detects the vibration, the relative magnitude (g) is shown on the graph.

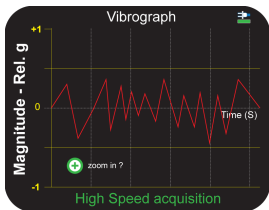

To change the scale and speed of the line graph, press the scale selection button or the speed selection button accordingly.



## Setting Menu Display Screen and Button Function

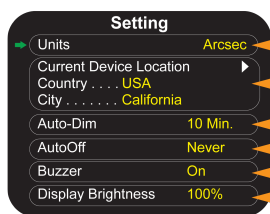

Setting Parameters

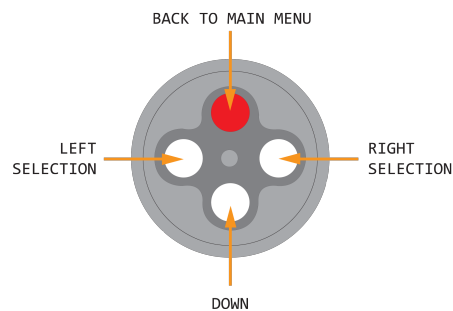

- |                         |  |
|-------------------------|--|
| Units                   | To change the measuring unit (arcsec., mm/M, mil(NATO) & mrad).                          |
| Current Device Location | When the device detects the vibration, the relative magnitude (g) is shown on the graph. |
| AutoOff                 | To set automatic power off according to user defined time period.                        |
| AutoDim                 | To set automatic dim according to user defined time period.                              |
| Buzzer                  | To turn on/off the device buzzer.  |
| Display Brightness      | To set LCD brightness according to user defined level.                                   |

## 5. STORAGE AND CLEANING

### Storage

Keep the device in the equipment box and maintain the storage temperature within -20°C to 60°C or -4°F to 140°F.

When the device is not in used, the batteries are to be removed from the device.

### Cleaning

1. Keep the device dry and clean. Remove any moisture or dirt with a soft dry cloth before measurement to obtain the maximum accuracy. Do not use harsh chemicals, strong detergents or cleaning solvent to clean the device.
2. Do not submerge device in liquid while cleaning.

## 6. WARRANTY

Digi-Pas® 2-Axis Ultra Precision Inclinometer is warranted to the original purchaser to be free from defects in workmanship and material. Digipas Technologies Inc. will, at its option, repair or replace any defective part which may malfunction under normal and proper use period of 2 (two) of purchase. The foregoing warranty shall not apply to defects resulting from misuse, abuse, assignment, or transfer by the Buyer, or interfacing, outside of environment the product. Digipas Technologies Inc. that the operation of instrument software, or firmware, will be uninterrupted or error-free. The exclusive remedy under any and all warrants and guarantees expressed herein, and we shall not be liable for damages from loss or delay of equipment uses, consequential, or incidental damage. No other Warranty is expressed or implied. Digipas Technologies Inc. specifically disclaims the implied warranties of merchantability and fitness for a particular purpose.

### Limitation of Liability:

In no event shall DIGIPAS TECHNOLOGIES INC., (hereinafter, "the Company") be liable to you or any third party for any indirect, special, incidental, exemplary or consequential damages of any kind resulting from any breach of warranty or from the performance or use of the product. This includes without limitation: property damage, loss of value of the product or any third party products that are used with the product, or loss of use of the product or any third party products that are used with the product, even if the Company has been advised of the possibility of such loss or damages. The Company's total cumulative liability arising from or related to the product, whether in contract, tort (including negligence) or otherwise, shall not exceed the amount actually paid by you for the product. Some states and/or jurisdictions do not allow the exclusion or limitation of incidental or consequential damages, so the above limitations or exclusions may not apply to you. If any limitation of liability shall be deemed invalid by any applicable law, then the limitations of liability set forth above shall apply to the maximum extent permitted under applicable law.

Disdtribute by:

Manufactured by:

JSB TECH PTE LTD

Email:[info@digipas.com](mailto:info@digipas.com)

**[www.digipas.com](http://www.digipas.com)**

## APPENDIX 1: USER CALIBRATION

### Calibration Instruments:

Granite Table: Grade AA (Levelled to  $\leq 0.5$  arcsec.)

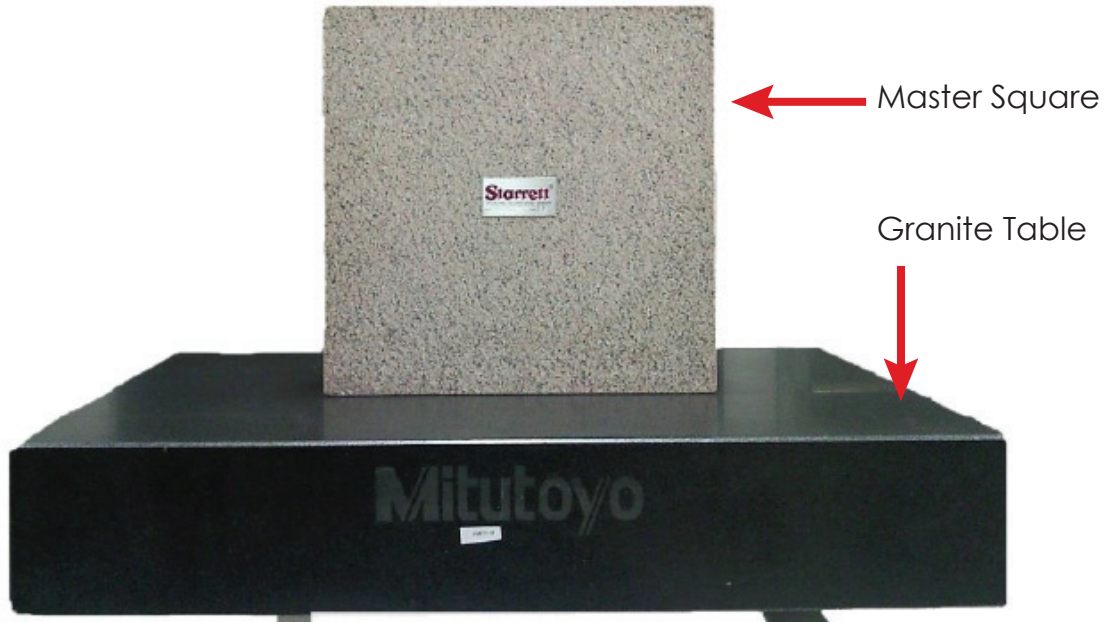

### Calibration Procedure:

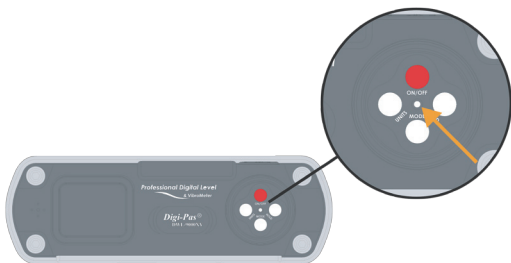

Ensure the DWL9000XY device is in power OFF condition. Press and hold the CAL button by using a small pin and simultaneously press the ON/OFF button.

The LCD screen displays "Calibration 1".



Place the device to **Position 1**. Press the MODE button once and wait until the countdown reach "0", the LCD screen displays "Calibration 2".

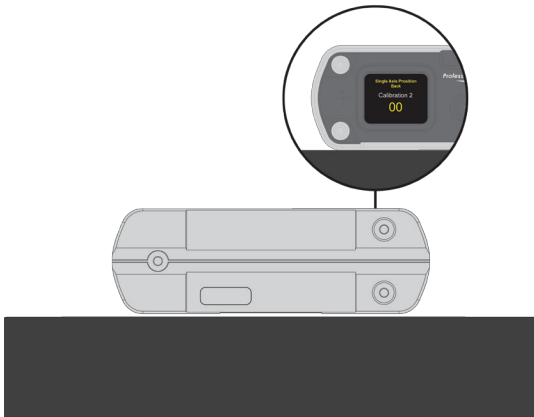

Turn the device 180° to **Position 2**. Press the MODE button again to start the calibration at "Position 2" and wait until the countdown reach "0", the LCD screen displays "Calibration 3".

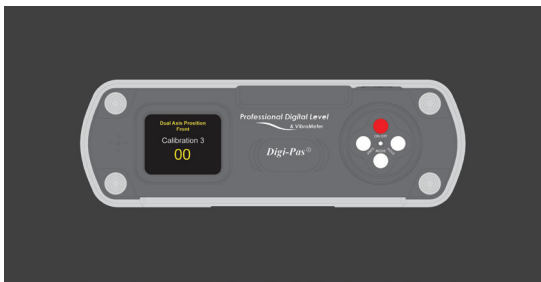

Place the device to **Position 3**. Press the MODE button once and wait until the countdown reach "0", the LCD screen display "Calibration 4".



Turn the device 180° to **Position 4**. Press the MODE button again and wait until the countdown reach "0", the LCD screen will switch to measuring mode once calibration is completed.

### Precaution:

To achieve maximum accuracy, the device must be held firmly on to jig during calibration process. Any movement on countdown during each calibration procedure would affect device accuracy.